

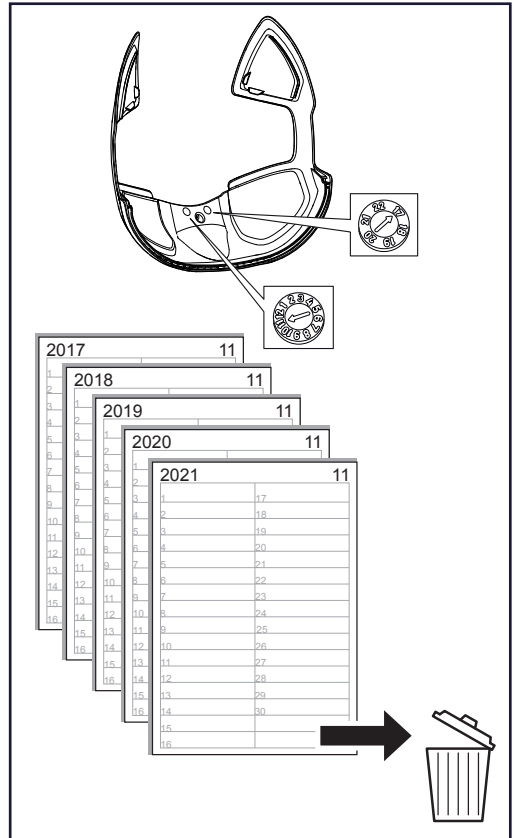

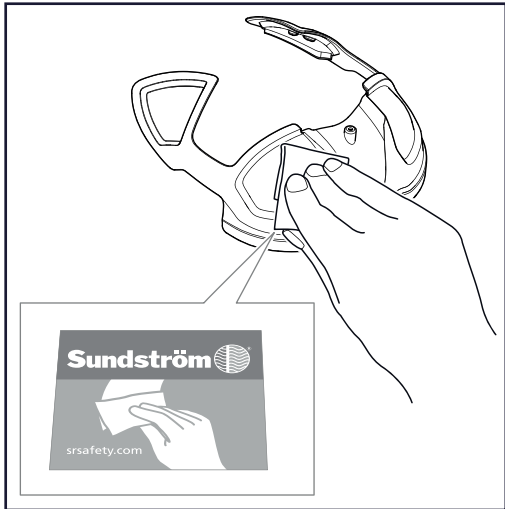

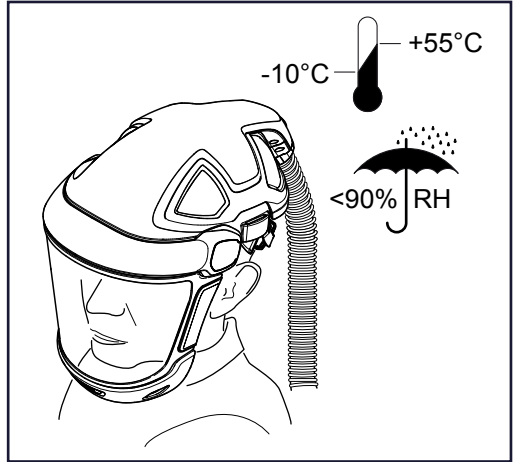

T06-0602, Bump cap

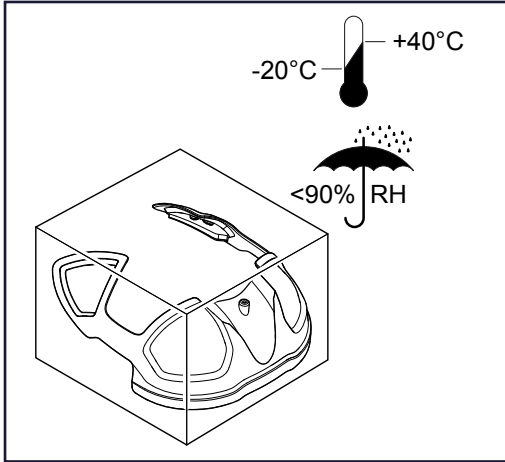

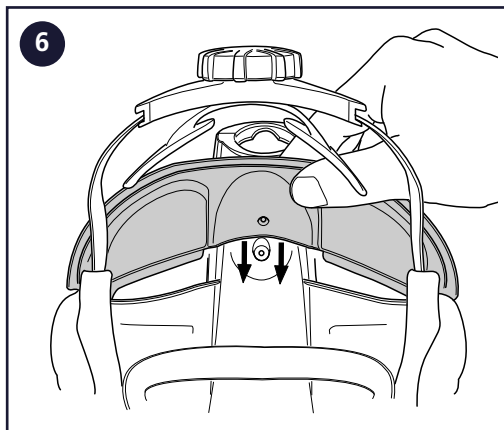
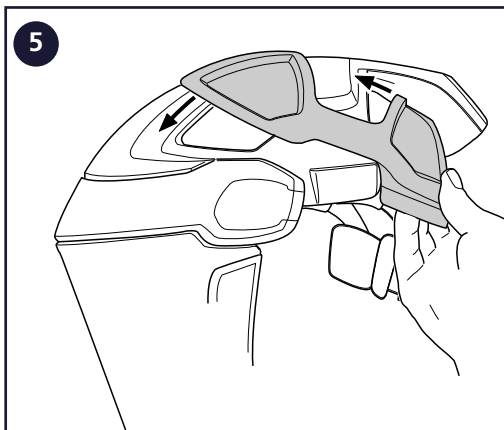
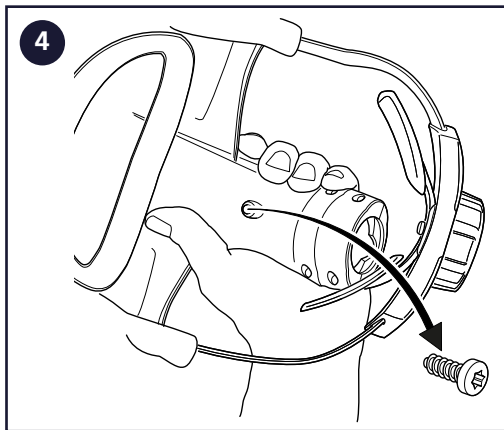
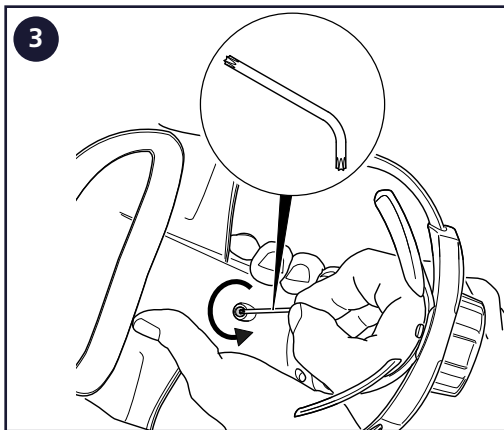
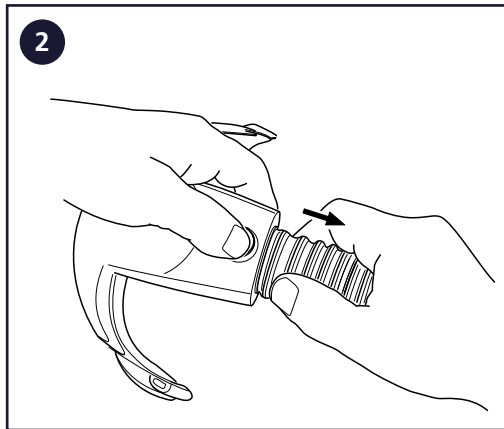
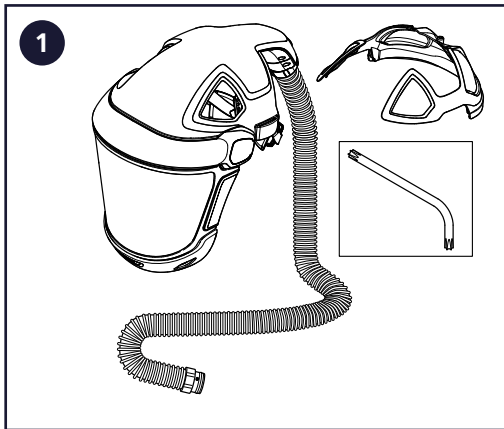
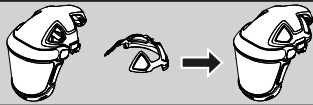

7

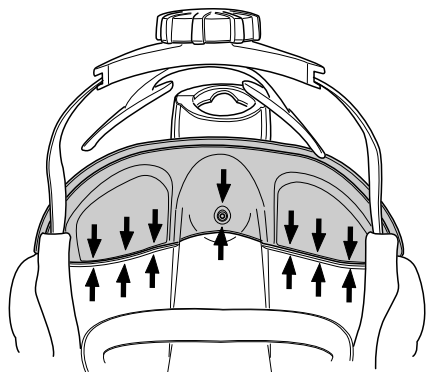

8

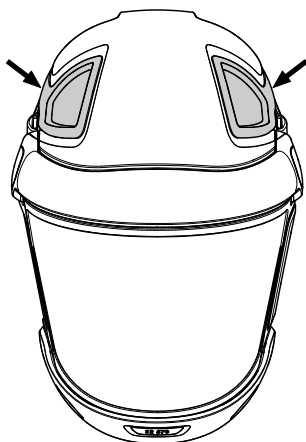

9

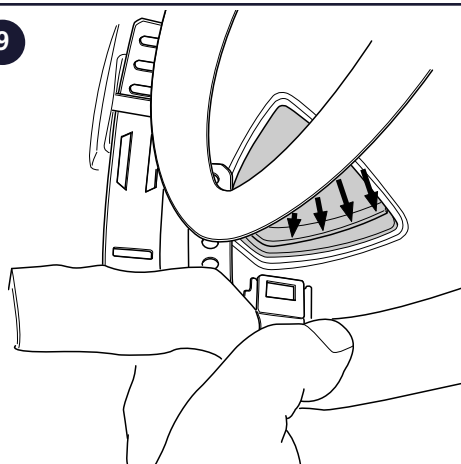

10

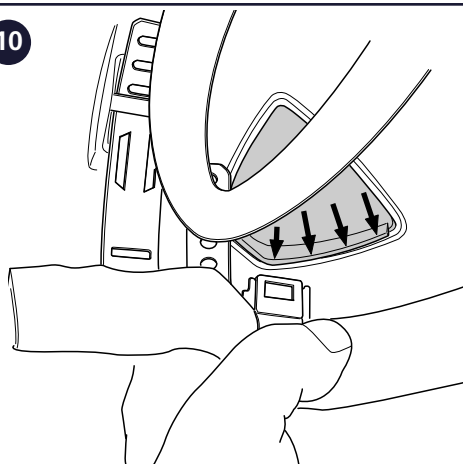

11

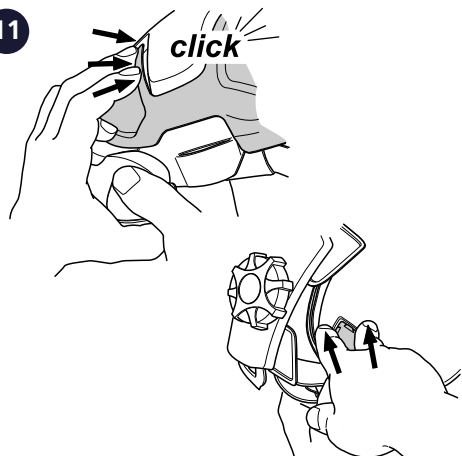

12

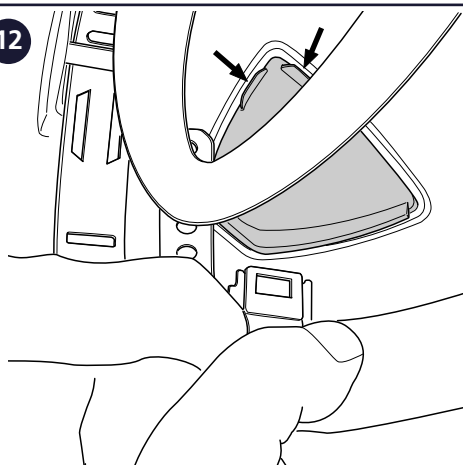

13

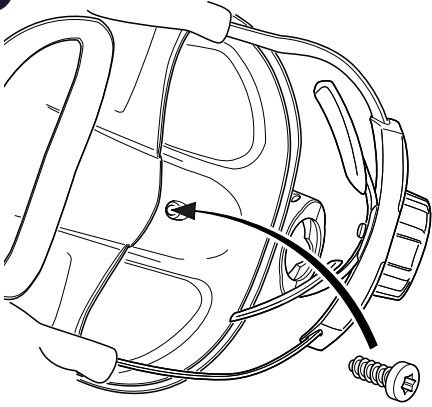

14

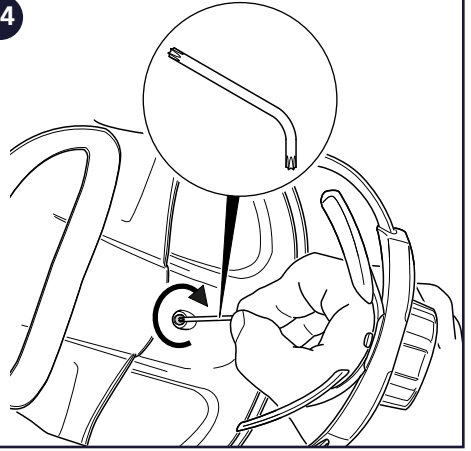

15

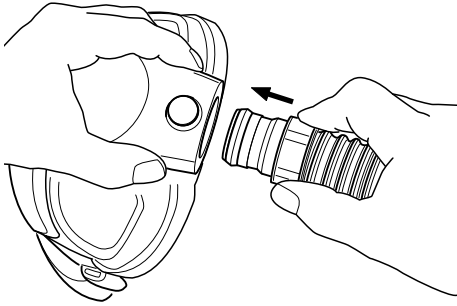

16

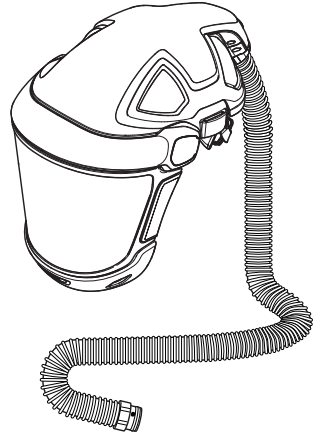

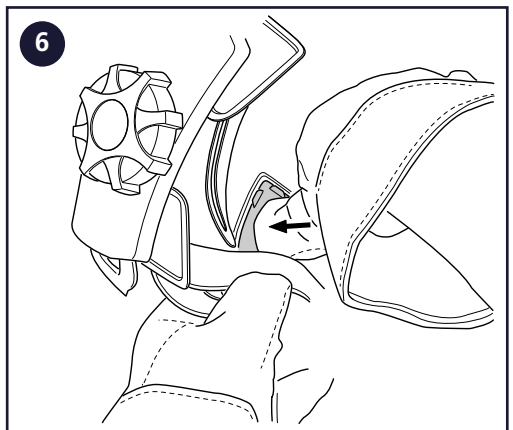
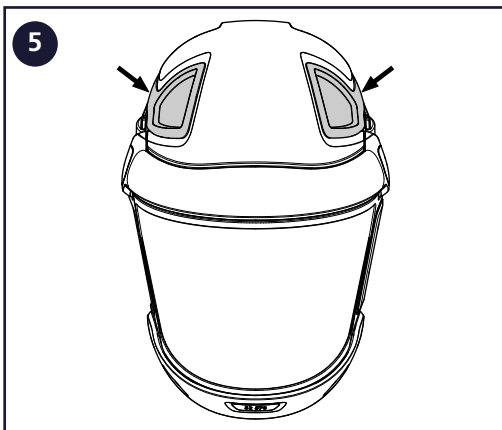
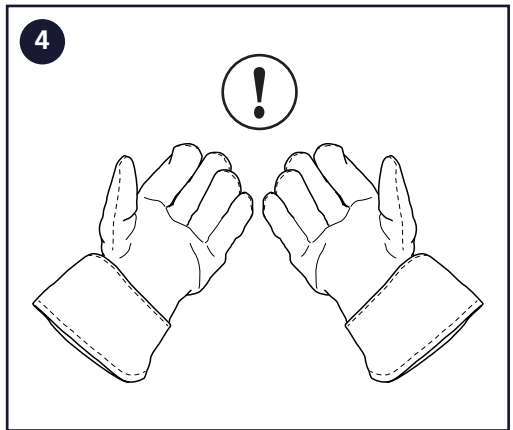
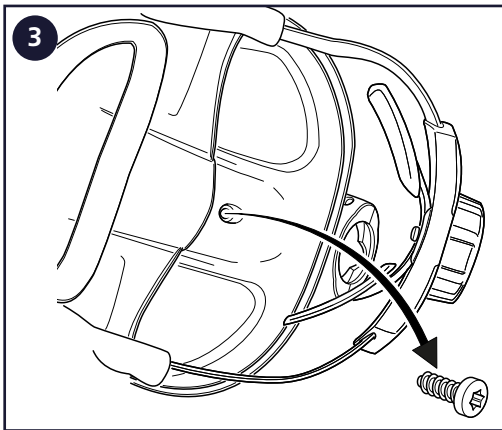
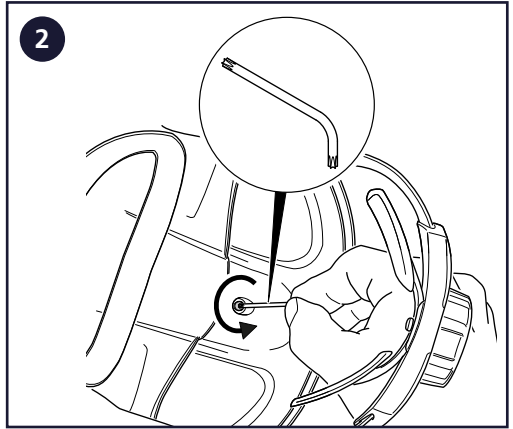
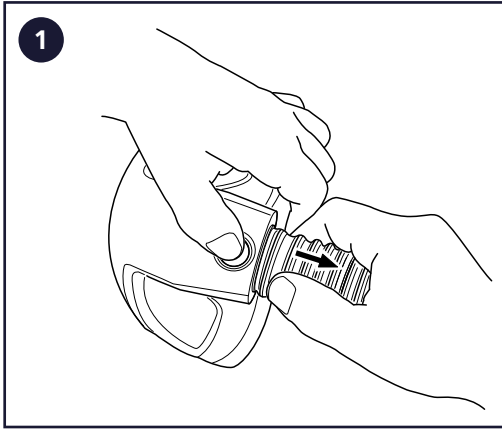
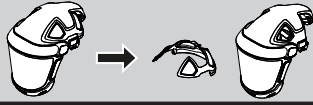



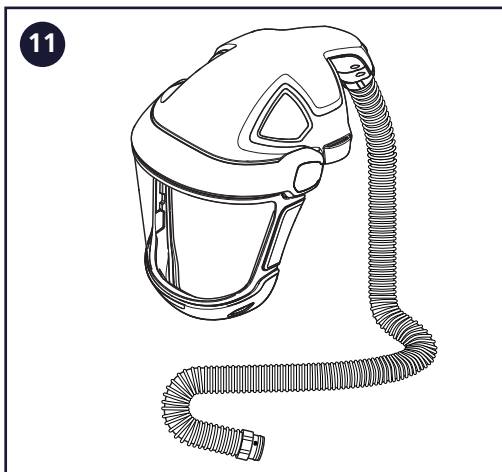
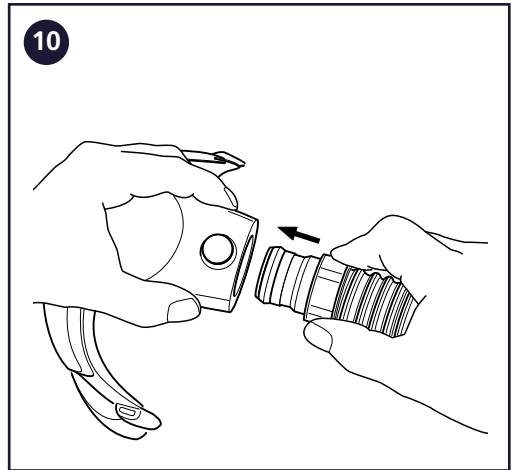
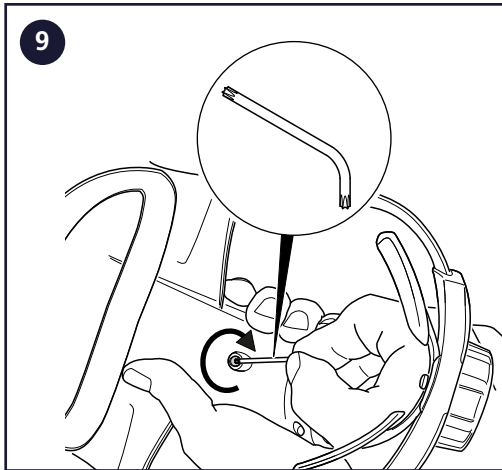
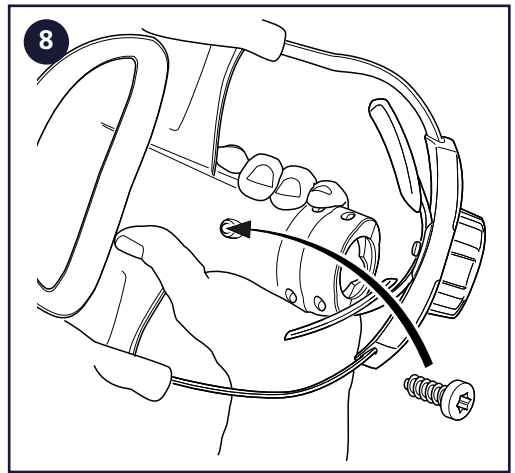
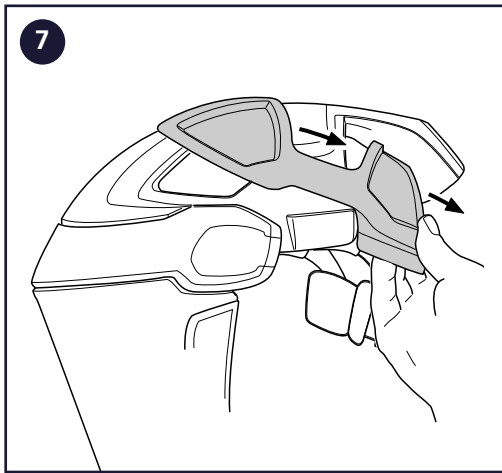

**The Bump cap T06-0602 is manufactured within a  
quality management system accepted by  
Notified Body 0194: INSPEC International Ltd.  
56 Leslie Hough Way,  
Salford, M6 6 AJ, England**



**Sundström Safety AB**  
SE-341 50 Lagan • Sweden  
Tel: +46 10 484 87 00  
info@srsafety.se • www.srsafety.com